

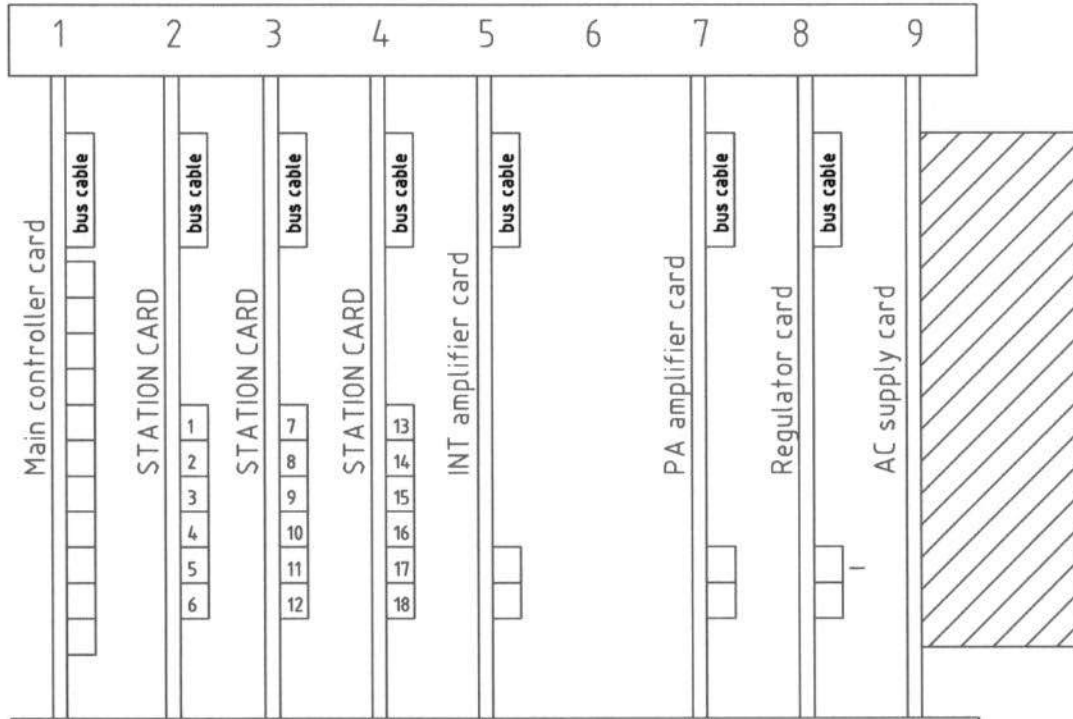

# FRONTVIEW

SYSTEM - 1

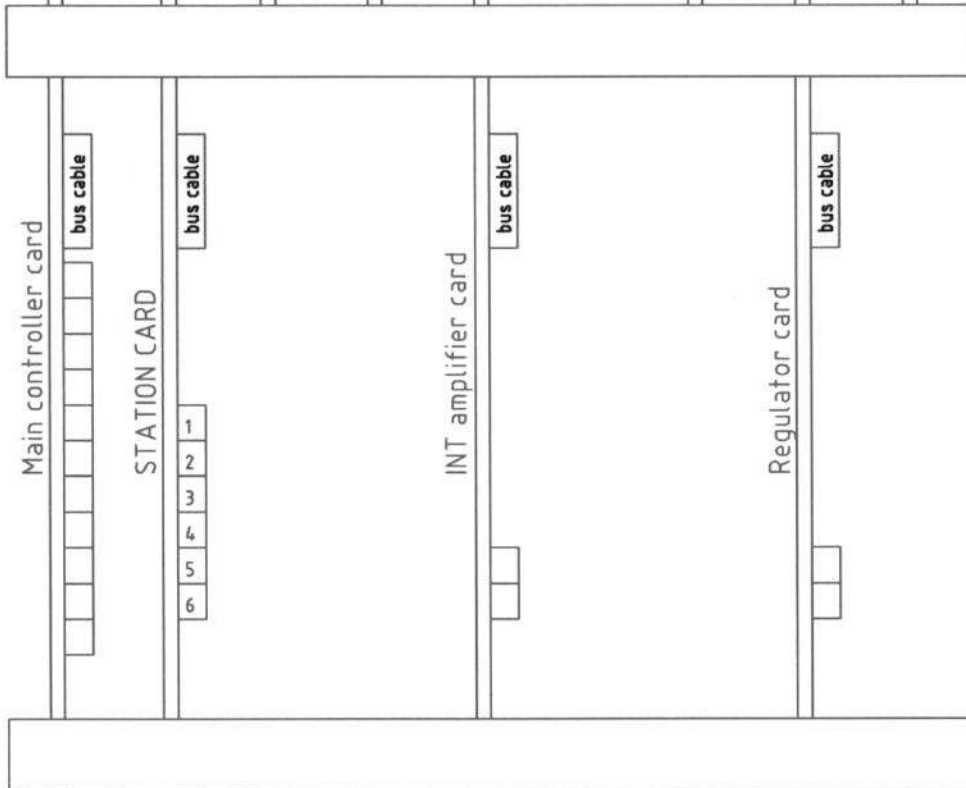

SYSTEM - 2



|  |               |       |           |          |         |         |             |           |  |
|--|---------------|-------|-----------|----------|---------|---------|-------------|-----------|--|
|  <b>HAGO Electronics</b><br>Radonstraat 179<br>2718 SV<br>ZOETERMEER<br>The Netherlands<br>tel: ++31(0)79-3617555<br>fax: ++31(0)79-3619555 | Blad          | 1 / 1 | Wijz. 01: | Getekend | fv      | Paraaf: | Contr. DAT: | Benaming  |  |
|  | Maateenheid   | mm    | Wijz. 02: | Datum    | 17-3-98 |         | Contr. PAR: |           | Shipcom card overview<br>main cabinet / 2 system |
|  | Schaal        | 1:1   | Wijz. 03: | Order    |         |         | Project     | Standaard |  |
|  | Amerik. Proj. |       | Wijz. 04: |          |         |         |             |           | Tek.nr.  |
|  |               |       | Wijz. 05: |          |         |         |             |           | A4   |

© HAGO Electronics

No part of this drawing may be used in any form without written permission of the owner.

CD / radio

FRONT VIEW OF DOUBLE SYSTEM CABINET

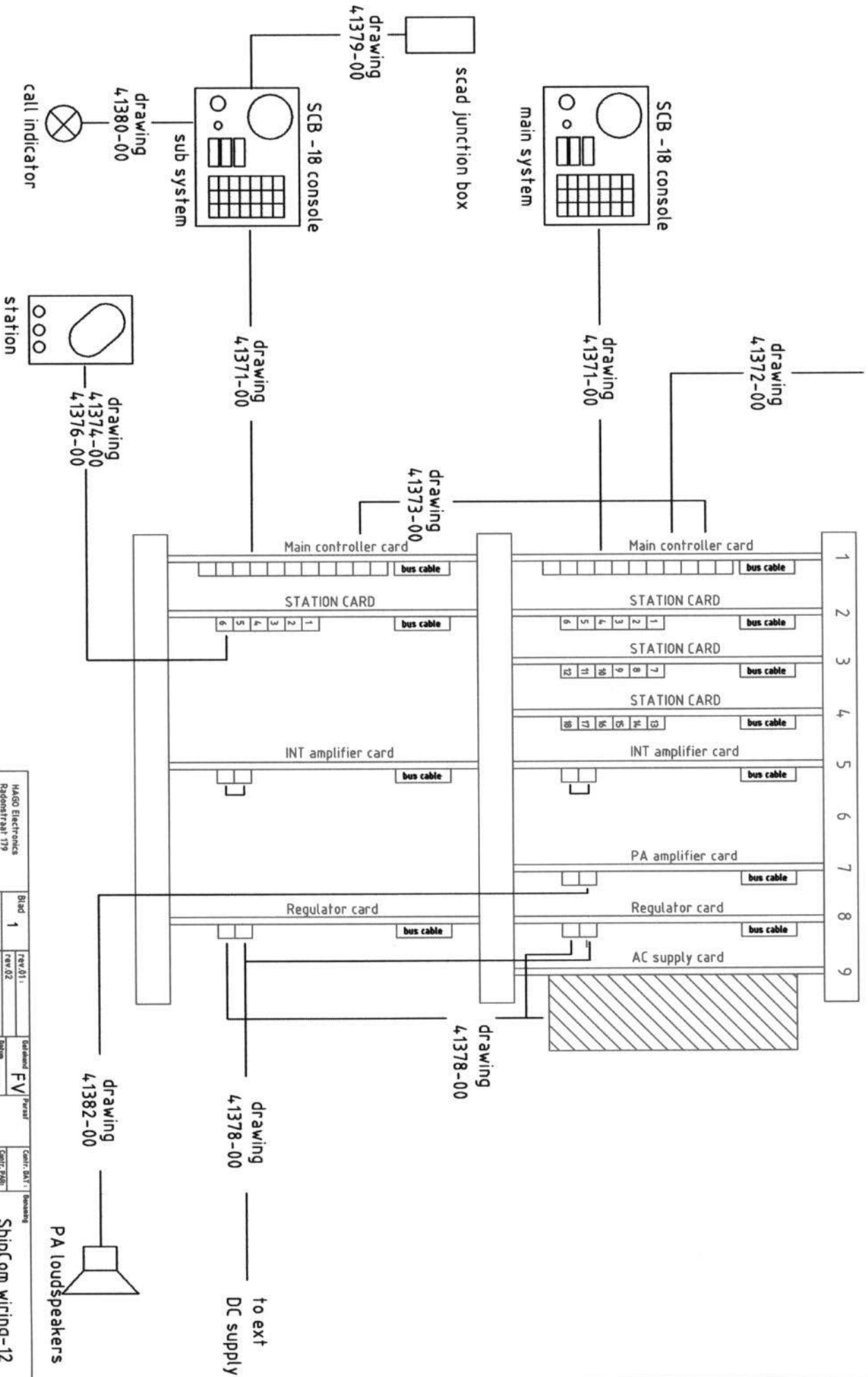

HASGO Electronics  
 Radonstraat 119  
 2718 SV Zoelernear  
 Tel (31) 79 3617555  
 Fax (31) 79 3619555  
 email: hasego@auron.nl

|            |        |         |         |             |                   |
|------------|--------|---------|---------|-------------|-------------------|
| Bid 1      | rev.01 | Gepland | F V     | Contr. DAT  | Bevestig          |
| Maatbeheer | rev.02 | Datum   | 18-3-98 | Contr. PA&B | ShipCom wiring-12 |
| N.V.T.     | rev.03 | Order   |         | Project     | ShipCom           |
|            | rev.04 |         |         | Value       | 4.1383-00         |
|            | rev.05 |         |         |             |                   |

© HASGO Electronics. No part of this drawing may be used in any form without written permission of HASGO Electronics.

# SCB connection to main controller card

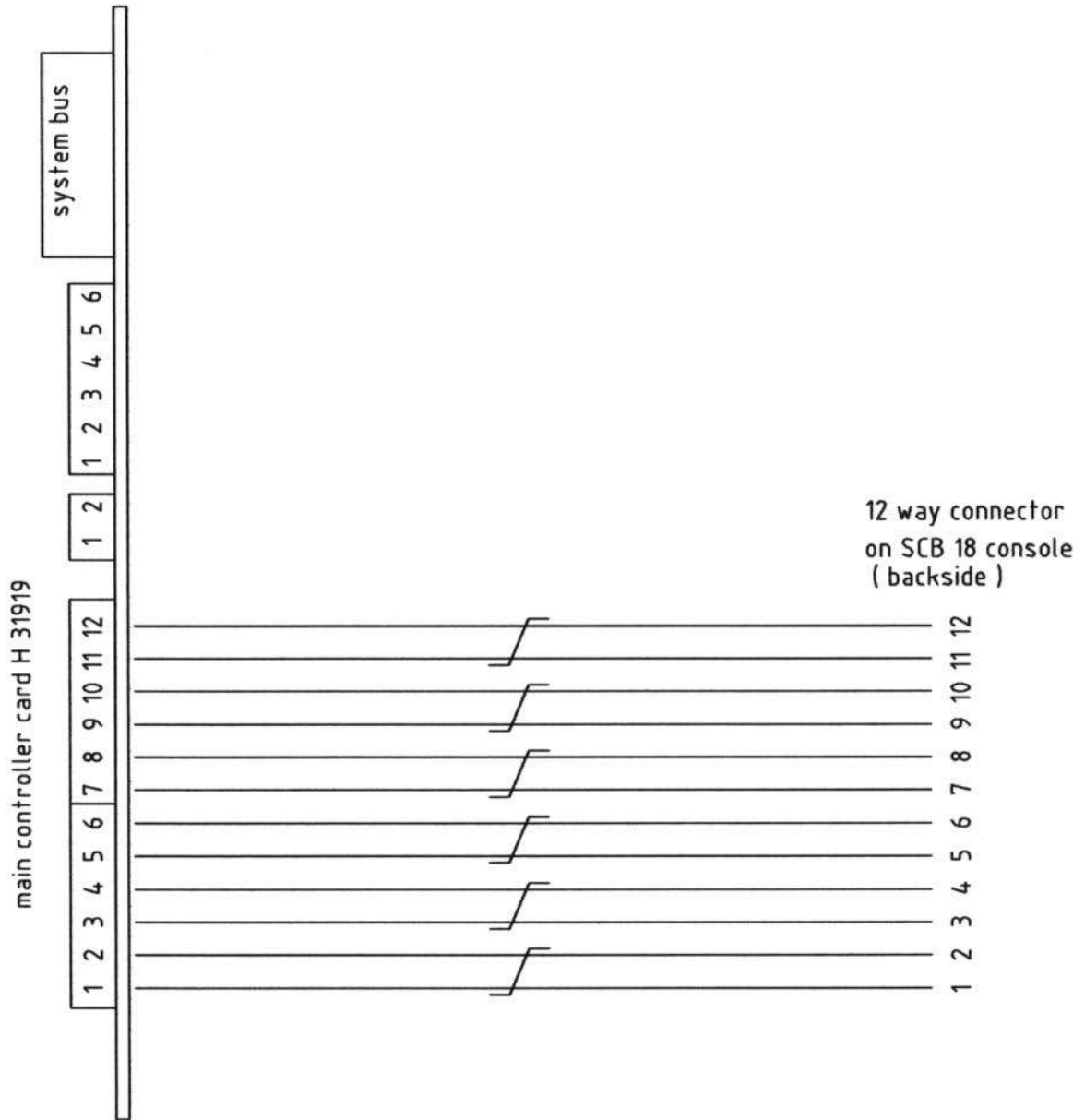

Frontview of card

|  |             |        |         |          |         |         |             |                  |
|--|-------------|--------|---------|----------|---------|---------|-------------|------------------|
| HAGO Electronics<br>Radonstraat 179<br>2718 Sv Zoetermeer<br>tel (31) 79 3617555<br>fax (31) 79 3619555<br>email hago@euronet.nl | Blad        | 1      | rev.01: | Getekend | FV      | Paraaf  | Contr. DAT: | Benaming         |
|  | Maateenheid | n.v.t. | rev.02: | Datum    | 17-3-98 | Order : | Contr. PAR: | ShipCom wiring-1 |
|  |             |        | rev.03: | Project  | ShipCom |         | Tek.nr.     | 41371-00         |
|  |             |        | rev.04: |          |         |         |             |                  |
|  |             |        | rev.05: |          |         |         |             |                  |
| © HAGO Electronics No part of this drawing may be used in any form without written permission of HAGO Electronics                |             |        |         |          |         |         |             |                  |

## Connecting external source to main controllercard

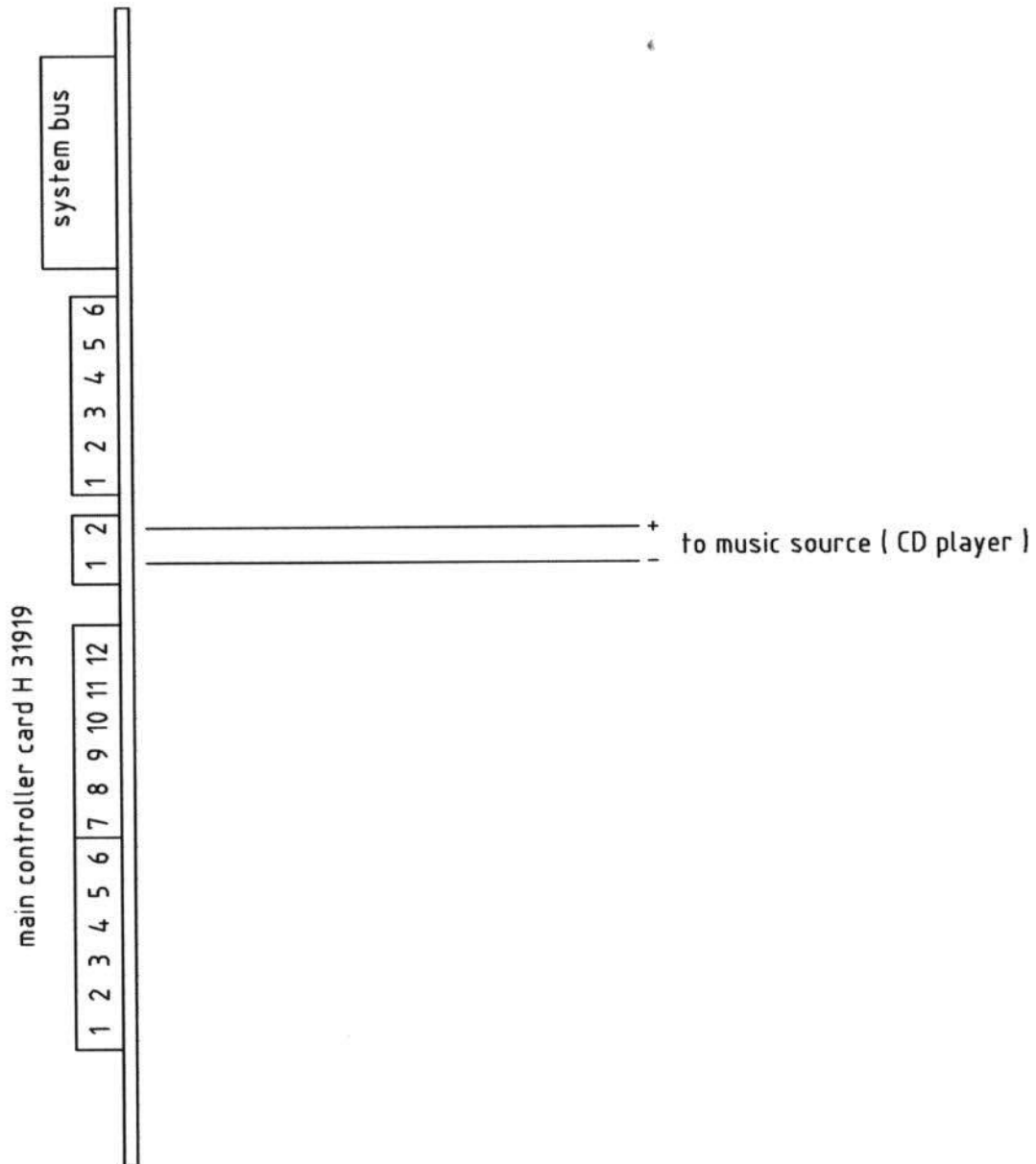

Frontview of card

|  |             |        |          |  |          |         |        |  |              |                  |
|--|-------------|--------|----------|--|----------|---------|--------|--|--------------|------------------|
| HAGO Electronics<br>Radonstraat 179<br>2718 Sv Zoetermeer<br>tel (31) 79 3617555<br>fax (31) 79 3619555<br>email hago@euronof.nl | Blad        | 1      | rev.01 : |  | Getekend | FV      | Paraaf |  | Contr. DAT : | Benaming         |
|  | Maateenheid | n.v.t. | rev.02   |  | Datum    | 17-3-98 |        |  | Contr. PAR:  | ShipCom wiring-2 |
|  |             |        | rev.03   |  | Order :  |         |        |  | Project      | ShipCom          |
|  |             |        | rev.04   |  |          |         |        |  | Tek.nr.      | 41372-00         |
|  |             |        | rev.05   |  |          |         |        |  |              |                  |
| © HAGO Electronics No part of this drawing may be used in any form without written permission of HAGO Electronics                |             |        |          |  |          |         |        |  |              |                  |

# Connecting 2 main controller cards when using 2 SCB 18

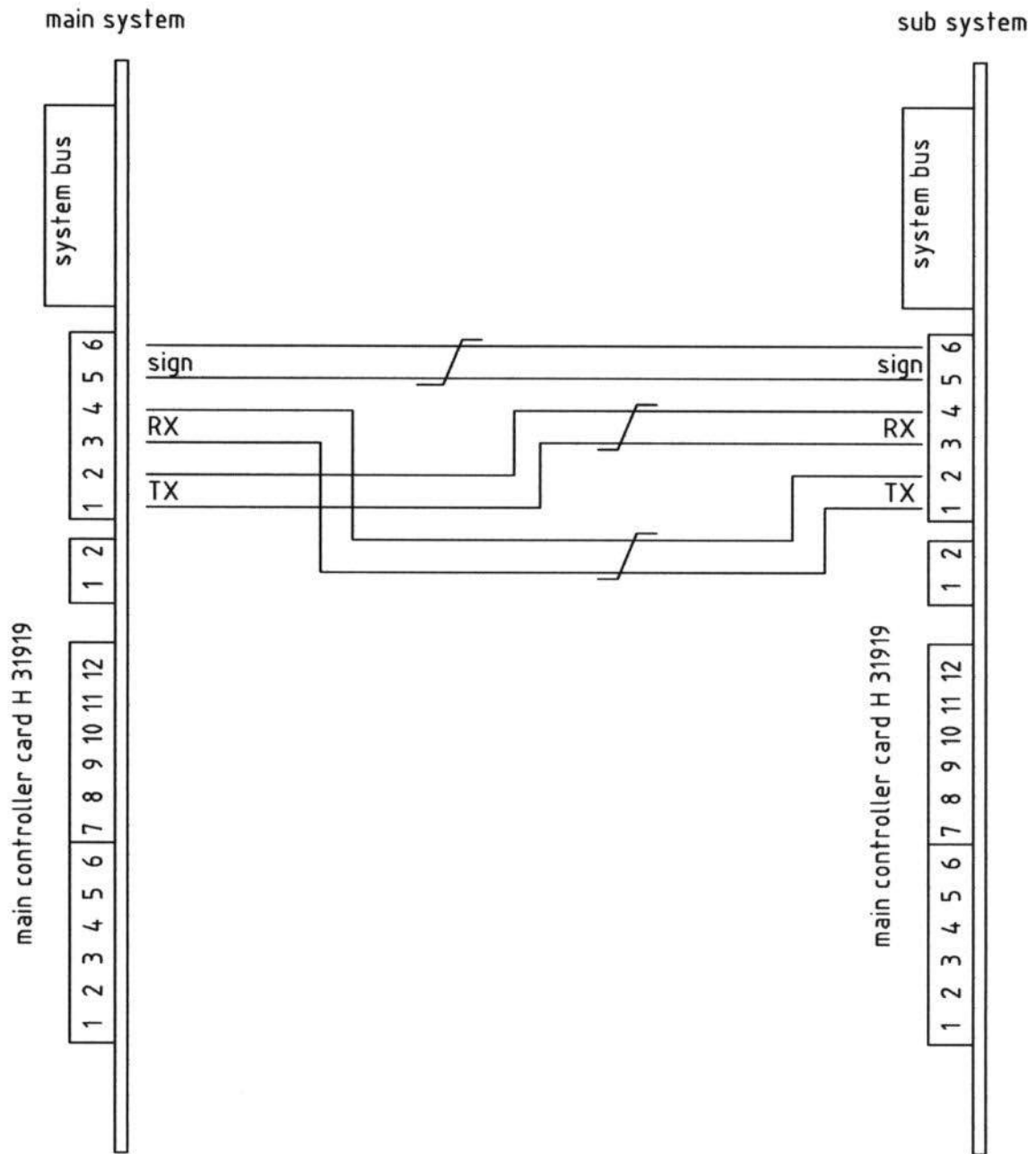

Frontview of cards

|  |             |        |         |          |         |        |             |                  |          |
|--|-------------|--------|---------|----------|---------|--------|-------------|------------------|----------|
| HAGO Electronics<br>Radonstraat 179<br>2718 Sv Zoetermeer<br>tel (31) 79 3617555<br>fax (31) 79 3619555<br>email hago@euronet.nl | Blad        | 1      | rev.01: | Getekend | FV      | Paraaf | Contr. DAT: | Benaming         |          |
|  | Maateenheid | n.v.t. | rev.02  | Datum    | 17-3-98 | Order: | Contr. PAR: | ShipCom wiring-3 |          |
|  |             |        | rev.03  | Project  | ShipCom |        |             |                  |          |
|  |             |        | rev.04  |          |         |        | Tek.nr.     |                  | 41373-00 |
|  |             |        | rev.05  |          |         |        |             |                  |          |
| © HAGO Electronics No part of this drawing may be used in any form without written permission of HAGO Electronics                |             |        |         |          |         |        |             |                  |          |

# Connecting 6 stations to station card

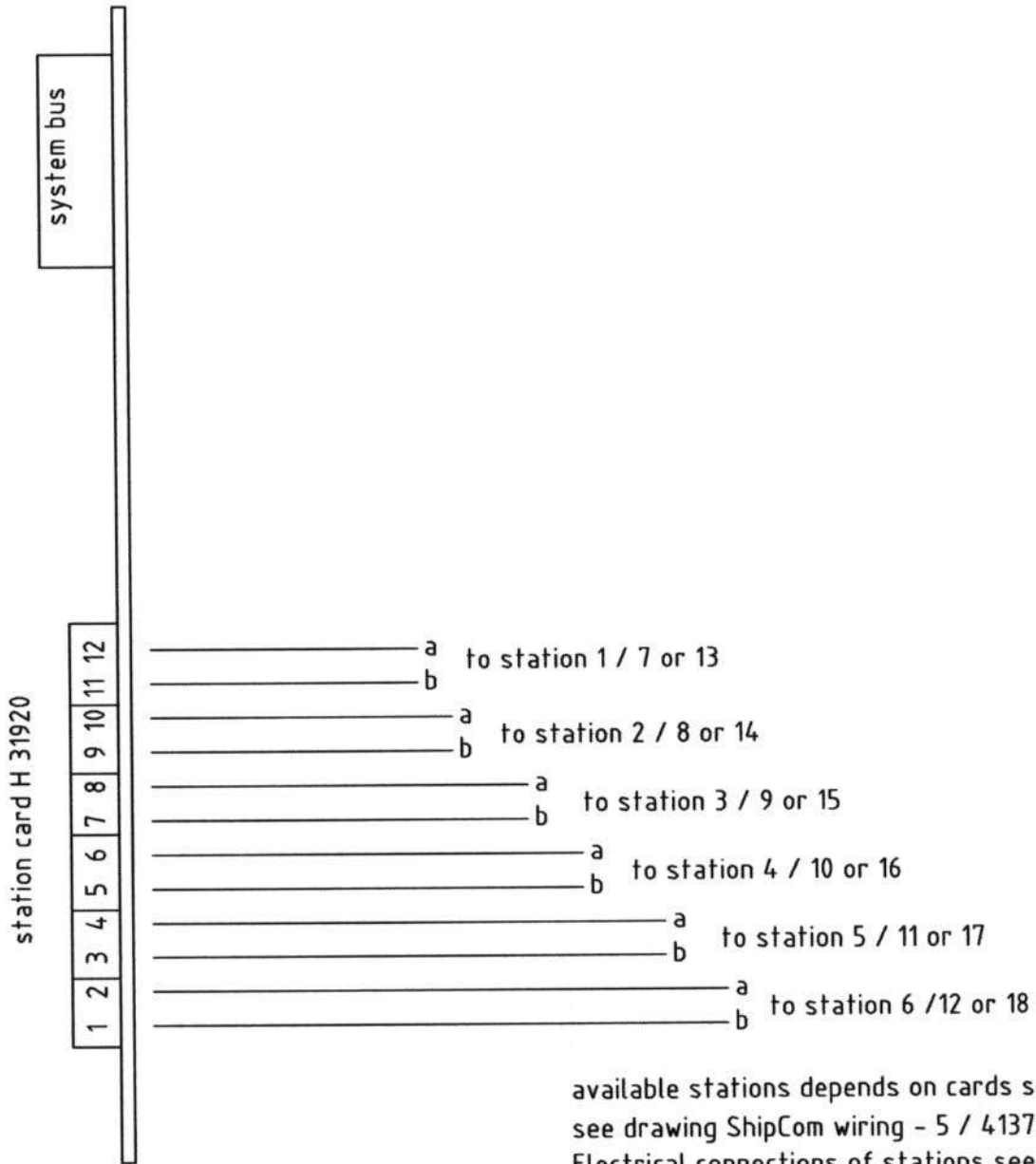

available stations depends on cards settings  
see drawing ShipCom wiring - 5 / 41375-00.  
Electrical connections of stations see drawing  
ShipCom wiring -6 / 41376-00

|  |             |        |          |          |         |        |              |                  |          |
|--|-------------|--------|----------|----------|---------|--------|--------------|------------------|----------|
| HAGO Electronics<br>Radonstraat 179<br>2718 Sv Zoetermeer<br>tel (31) 79 3617555<br>fax (31) 79 3619555<br>email hago@euronet.nl | Blad        | 1      | rev.01 : | Gefekend | FV      | Paraaf | Contr. DAT : | Benaming         |          |
|  |             |        | rev.02 : |          |         |        |              | ShipCom wiring-4 |          |
|  | Maateenheid | n.v.t. | rev.03 : | Datum    | 17-3-98 |        | Contr. PAR : |                  |          |
|  |             |        | rev.04 : | Order :  |         |        | Project      | ShipCom          | Tek.nr.  |
|  |             |        | rev.05 : |          |         |        |              |                  | 41374-00 |
| © HAGO Electronics No part of this drawing may be used in any form without written permission of HAGO Electronics                |             |        |          |          |         |        |              |                  |          |

# Stationcard configuration ( H 31920 )

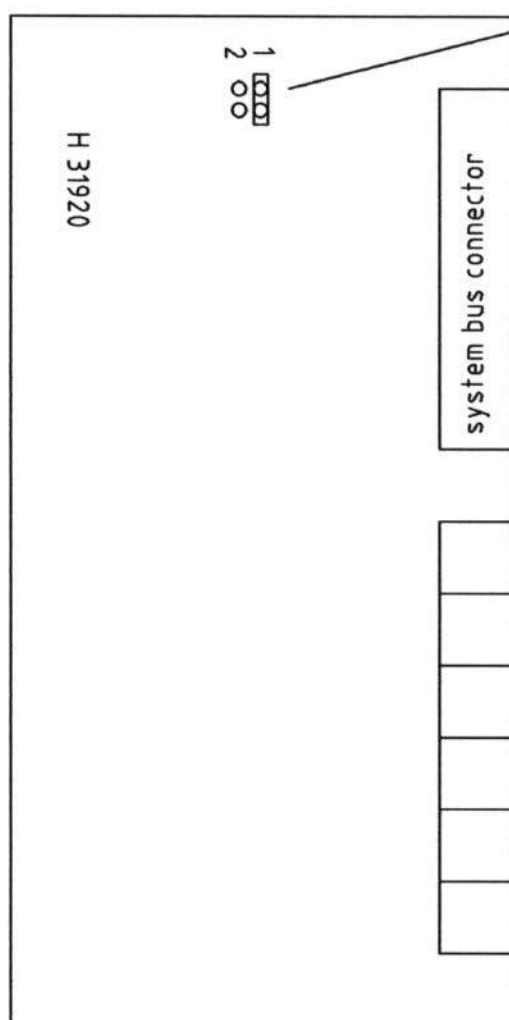

Card address

No links placed address 0

link placed on 1 / address 1 ( as drawn )

link placed on 2 / address 2

## Available stations on card address

| card nr 0  | card nr 1  | card nr 2   |
|------------|------------|-------------|
| stations 1 | stations 7 | stations 13 |
| 2          | 8          | 14          |
| 3          | 9          | 15          |
| 4          | 10         | 16          |
| 5          | 11         | 17          |
| 6          | 12         | 18          |

|  |             |   |         |          |         |        |             |                  |
|--|-------------|---|---------|----------|---------|--------|-------------|------------------|
| HAGO Electronics<br>Radonstraat 179<br>2718 Sv Zoetermeer<br>tel (31) 79 3617555<br>fax (31) 79 3619555<br>email hago@euronet.nl | Blad        | 1 | rev.01: | Getekend | FV      | Paraaf | Contr. DAT: | Benaming         |
|  |             |   | rev.02  |          |         |        |             |                  |
|  | Maateenheid |   | rev.03  | Datum    | 17-3-98 |        | Contr. PAR: | ShipCom wiring-5 |
|  |             |   | rev.04  | Order:   |         |        | Project     | ShipCom          |
|  | n.v.t.      |   | rev.05  |          |         |        | Tek.nr.     | 41375-00         |
| © HAGO Electronics No part of this drawing may be used in any form without written permission of HAGO Electronics                |             |   |         |          |         |        |             |                  |

# Station connection to stationcard

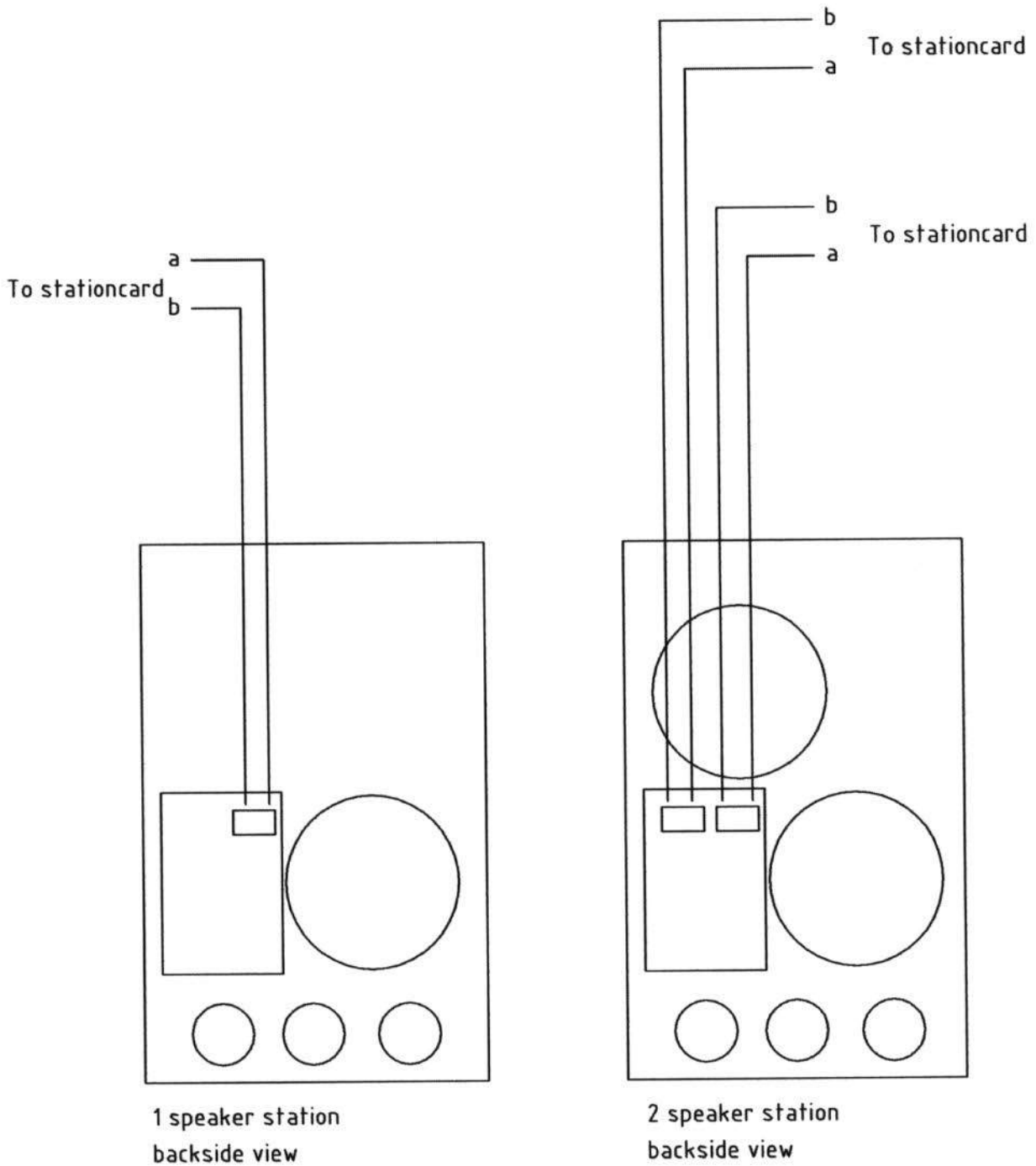

|  |             |          |          |         |              |                  |                  |
|--|-------------|----------|----------|---------|--------------|------------------|------------------|
| HAGO Electronics<br>Radonstraat 179<br>2718 Sv Zoetermeer<br>tel (31) 79 3617555<br>fax (31) 79 3619555<br>email hago@euronet.nl | Blad        | rev.01 : | Getekend | Paraaf  | Contr. DAT : | Benaming         |                  |
|  | 1           | rev.02   | FV       |         |              | ShipCom wiring-6 |                  |
|  | Maateenheid | rev.03   | Datum    |         | Contr. PAR : |                  |                  |
|  | n.v.t.      | rev.04   | 17-3-98  | Order : | Project      | ShipCom          | Tek.nr. 41376-00 |
|  |             | rev.05   |          |         |              |                  |                  |



# Connecting external DC supply to regulator card

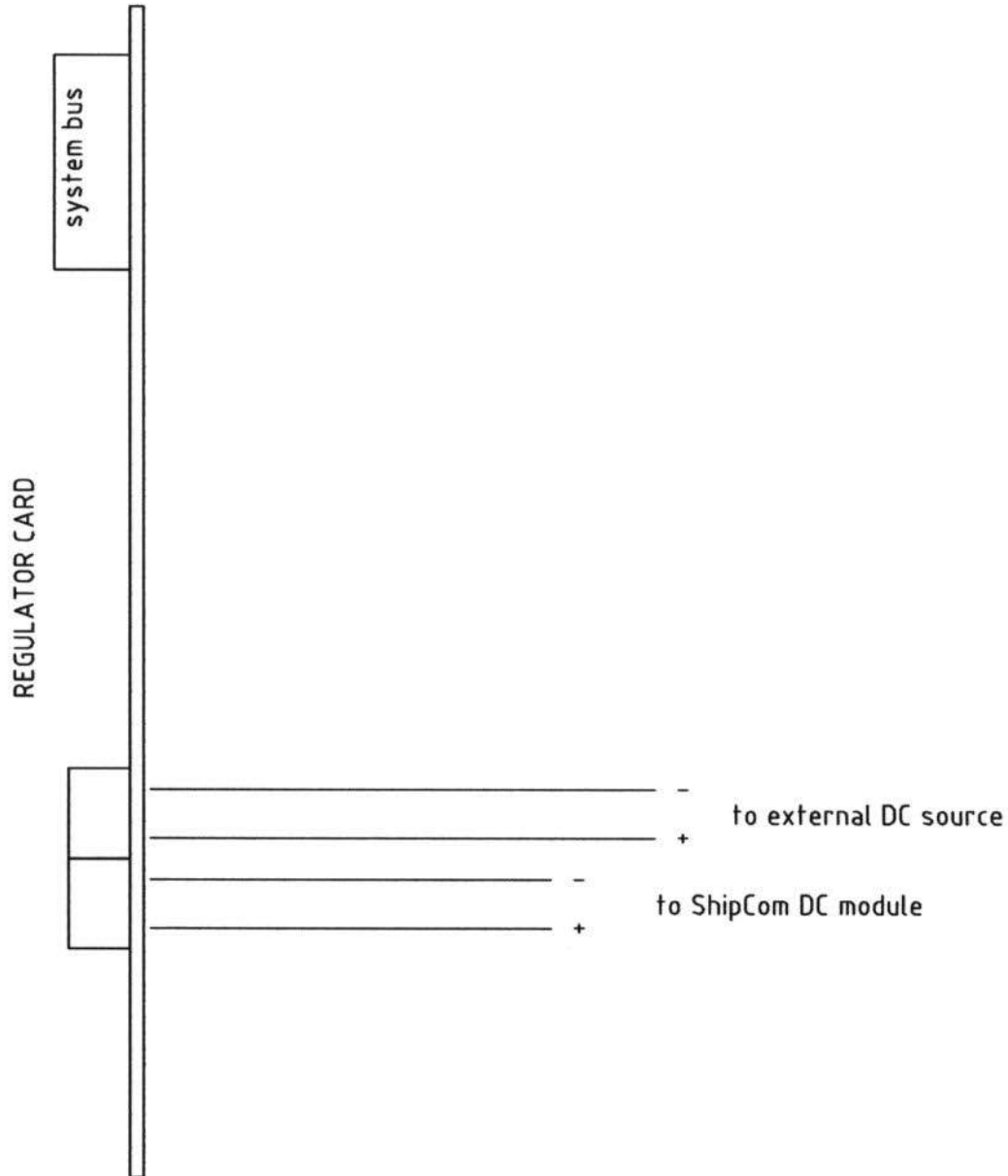

|  |             |          |          |         |              |                  |          |
|--|-------------|----------|----------|---------|--------------|------------------|----------|
| HAGO Electronics<br>Radonstraat 179<br>2718 Sv Zoetermeer<br>tel (31) 79 3617555<br>fax (31) 79 3619555<br>email hago@euronet.nl | Blad        | rev.01 : | Gefekend | Paraaf  | Contr. DAT : | Benaming         |          |
|  | 1           | rev.02   | FV       |         |              | ShipCom wiring-7 |          |
|  | Maateenheid | rev.03   | Datum    |         | Contr. PAR:  |                  |          |
|  | n.v.t.      | rev.04   | 17-3-98  | Order : | Project      | ShipCom          | Tek.nr.  |
|  |             | rev.05   |          |         |              |                  | 41378-00 |

## Connecting SCAD / headset junction box

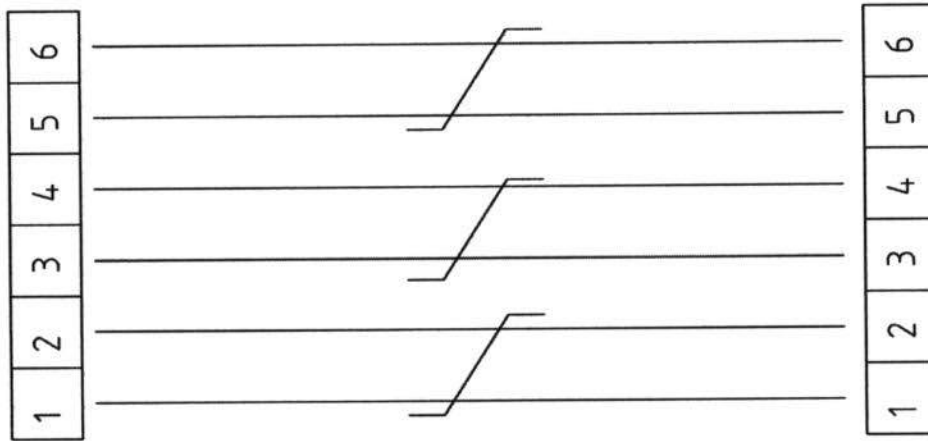

6 way connector  
on backside of SCB 18  
marked " HEADSET "

6 way BULGIN connector  
in SCAD junction box

|  |             |   |         |  |  |         |        |  |             |                  |
|--|-------------|---|---------|--|--|---------|--------|--|-------------|------------------|
| HAGO Electronics<br>Radonstraat 179<br>2718 Sv Zoetermeer<br>tel (31) 79 3617555<br>fax (31) 79 3619555<br>email hago@euronet.nl | Blad        | 1 | rev.01: |  | Getekend   | FV      | Paraaf |  | Contr. DAT: | Benaming         |
|  |             |   | rev.02  |  | Datum  | 17-3-98 |        |  | Contr. PAR: | ShipCom wiring-8 |
|  | Maateenheid |   | rev.03  |  | Order:   |         |        |  | Project     | ShipCom          |
|  | n.v.t.      |   | rev.04  |  |  |         |        |  | Tek.nr.     | 41379-00         |
|  |             |   | rev.05  |  | ©HAGO Electronics No part of this drawing may be used in any form without written permission of HAGO Electronics |         |        |  |             |                  |

external call indicator (lamp / siren)

24 volts DC

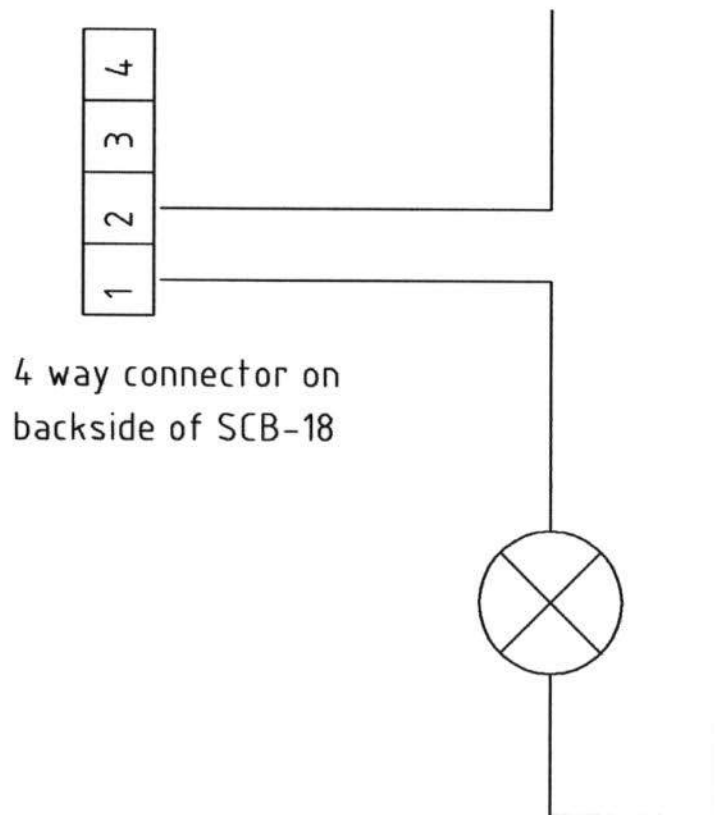

4 way connector on  
backside of SCB-18

|  |             |   |          |  |          |         |        |  |              |                  |
|--|-------------|---|----------|--|----------|---------|--------|--|--------------|------------------|
| HAGO Electronics<br>Radonstraat 179<br>2718 Sv Zoetermeer<br>tel (31) 79 3617555<br>fax (31) 79 3619555<br>email hago@euronet.nl | Blad        | 1 | rev.01 : |  | Getekend | FV      | Paraaf |  | Contr. DAT : | Benaming         |
|  |             |   | rev.02   |  | Datum    | 17-3-98 |        |  | Contr. PAR : | ShipCom wiring-9 |
|  | Maateenheid |   | rev.03   |  | Order :  |         |        |  | Project      | ShipCom          |
|  |             |   | rev.04   |  |          |         |        |  | Tek.nr.      | 41380-00         |
|  | n.v.t.      |   | rev.05   |  |          |         |        |  |              |                  |
| © HAGO Electronics No part of this drawing may be used in any form without written permission of HAGO Electronics                |             |   |          |  |          |         |        |  |              |                  |

## External PA relays contact

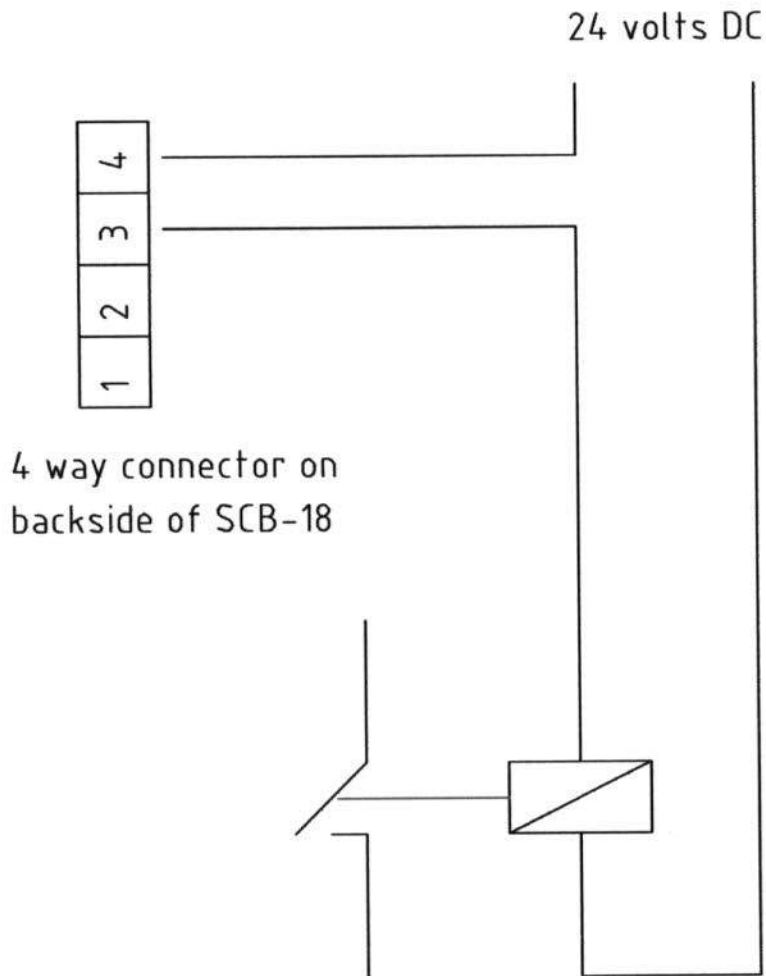

N.C. contact can be used to switch off sirens when making a call through the PA loudspeaker system

|  |             |          |          |         |              |                   |
|--|-------------|----------|----------|---------|--------------|-------------------|
| HAGO Electronics<br>Radonstraat 179<br>2718 Sv Zoetermeer<br>tel (31) 79 3617555<br>fax (31) 79 3619555<br>email hago@euronet.nl | Blad        | rev.01 : | Getekend | Paraaf  | Contr. DAT : | Benaming          |
|  | 1           | rev.02   | FV       |         |              | ShipCom wiring-10 |
|  | Maafteenhed | rev.03   | Datum    |         | Contr. PAR:  |                   |
|  | n.v.t.      | rev.04   | 17-3-98  | Order : | Project      | Tek.nr.           |
|  |             | rev.05   |          |         | ShipCom      | 41381-00          |
| © HAGO Electronics No part of this drawing may be used in any form without written permission of HAGO Electronics                |             |          |          |         |              |                   |

# Connecting PA loudspeakers to PA amplifier card

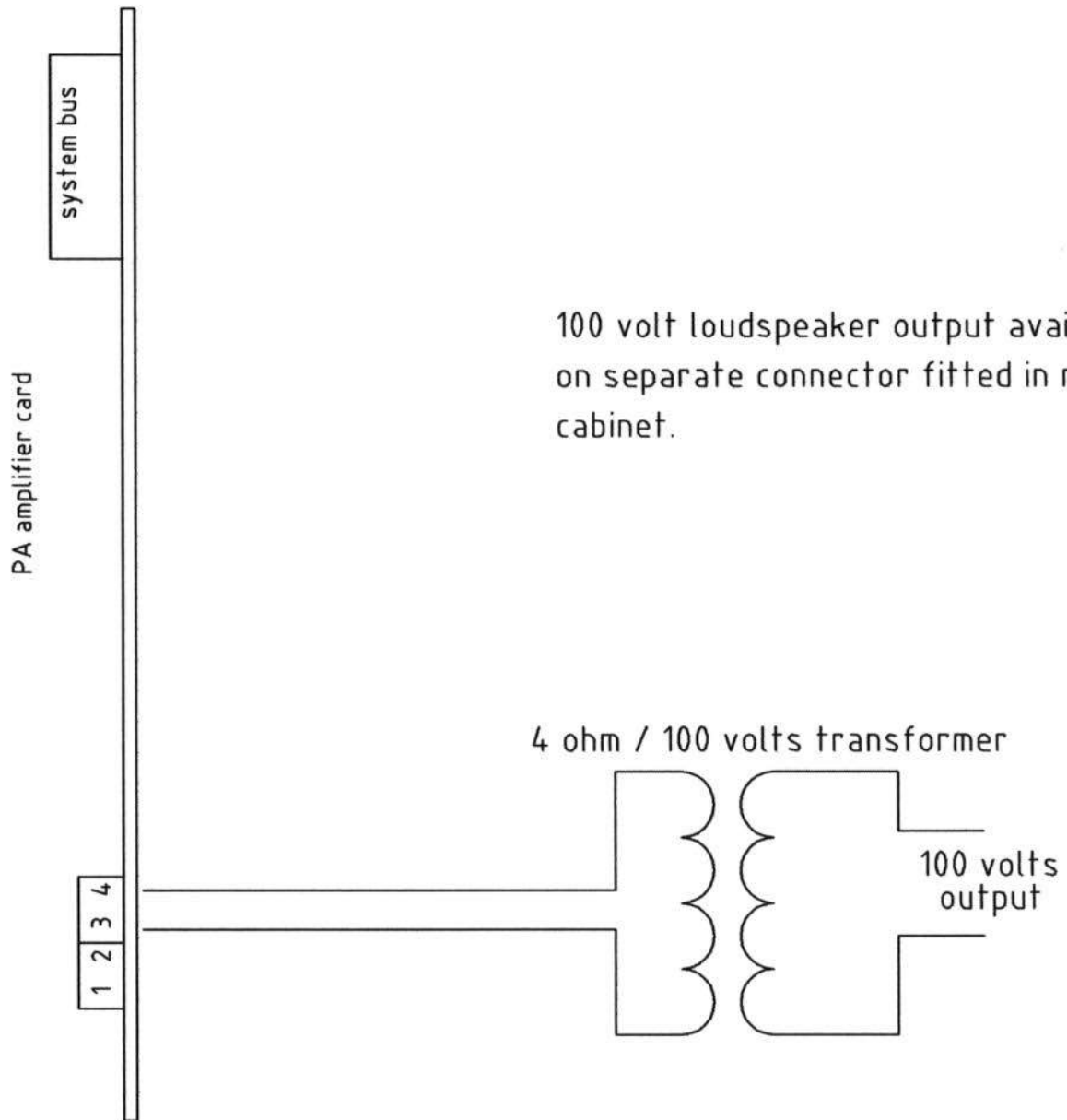

|  |             |        |          |  |          |         |         |         |              |                   |
|--|-------------|--------|----------|--|----------|---------|---------|---------|--------------|-------------------|
| HAGO Electronics<br>Radonstraat 179<br>2718 Sv Zoetermeer<br>tel (31) 79 3617555<br>fax (31) 79 3619555<br>email hago@euronet.nl | Blad        | 1      | rev.01 : |  | Gefekend | FV      | Paraaf  |         | Contr. DAT : | Benaming          |
|  |             |        | rev.02 : |  | Datum    | 17-3-98 |         |         | Contr. PAR:  | ShipCom wiring-11 |
|  | Maateenheid | n.v.t. | rev.03 : |  | Order :  |         | Project | ShipCom | Tek.nr.      |                   |
|  |             |        | rev.04 : |  |          |         |         |         | 41382-00     |                   |
|  |             |        | rev.05 : |  |          |         |         |         |              |                   |
| © HAGO Electronics No part of this drawing may be used in any form without written permission of HAGO Electronics                |             |        |          |  |          |         |         |         |              |                   |

# Frontview of LS junctionbox Type SCAD / artnr 96800210

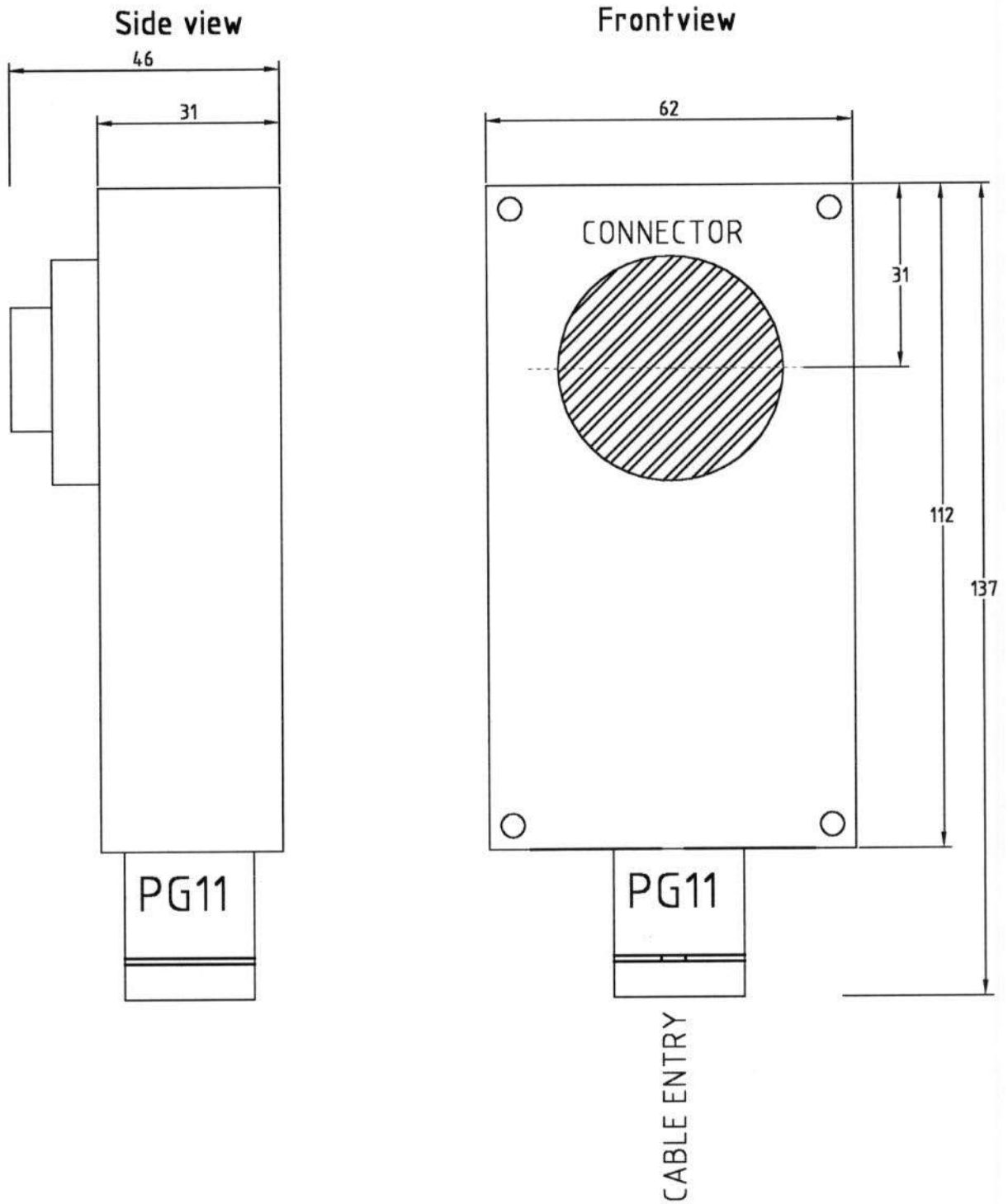

|  |               |       |           |          |          |            |            |          |          |                     |
|--|---------------|-------|-----------|----------|----------|------------|------------|----------|----------|---------------------|
|  <b>HAGO Electronics</b><br>Radonstraat 179<br>2718 SV<br>ZOETERMEER<br>The Netherlands<br>tel: ++31(0)79-3617555<br>fax: ++31(0)79-3619555 | Blad          | 1 / 1 | Wijz. 01: | Getekend | FV       | Paroaf:    | Conr. DAT: | 12-11-97 | Benaming | SCAD LS junctionbox |
|  | Maateenheid   | mm    | Wijz. 02: | Datum    | 12-11-97 | Conr. PAR: |            |          | 96800210 |                     |
|  | Schaal        | 1:1   | Wijz. 03: | Order    |          | Project    | Standaard  | Tek.nr.  | 4.1338   | A4                  |
|  | Amerik. Proj. |       | Wijz. 04: |          |          |            |            |          |          |                     |
|  |               |       | Wijz. 05: |          |          |            |            |          |          |                     |
| © HAGO Electronics No part of this drawing may be used in any form without written permission of the owner.  |               |       |           |          |          |            |            |          |          |                     |

# Frontview of headset junction box Type SCAT / artnr 96800211

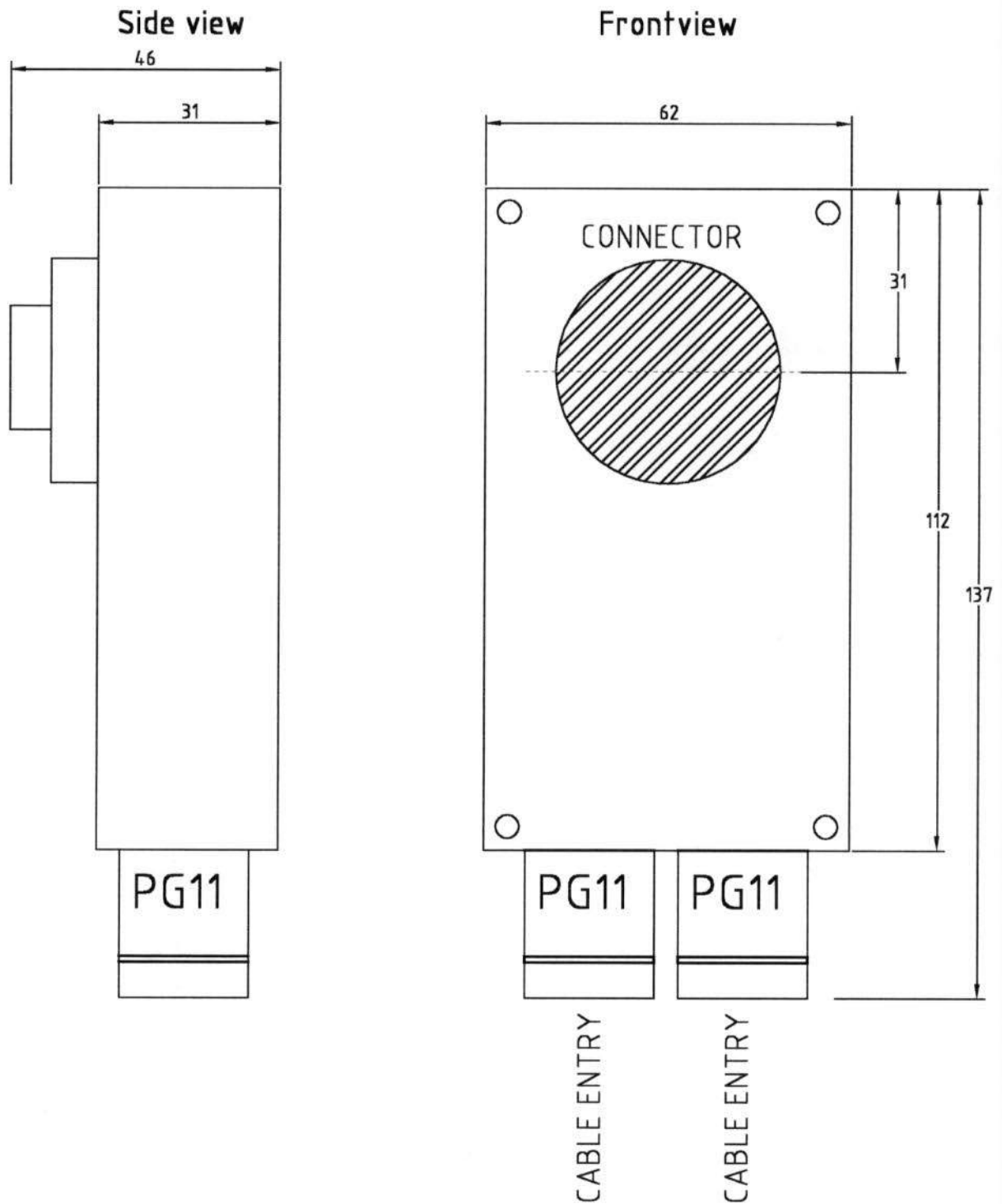

|  |               |       |           |          |          |             |            |          |          |          |
|--|---------------|-------|-----------|----------|----------|-------------|------------|----------|----------|----------|
|  <b>HAGO Electronics</b><br>Radonstraat 179<br>2718 SV<br>ZOETERMEER<br>The Netherlands<br>tel: ++31(0)79-3617555<br>fax: ++31(0)79-3619555 | Blad          | 1 / 1 | Wijz. 01: | Getekend | FV       | Paraaf:     | Contr. DA: | 12-11-97 | Benaming | SCAT BOX |
|  | Maateenheid   | mm    | Wijz. 02: | Datum    | 12-11-97 | Contr. PAR: |            | 96800211 |          |          |
|  | Schaal        | 1:1   | Wijz. 03: | Order    |          | Project     | Standaard  | Tek.nr.  | 41337    | A4       |
|  | Amerik. Proj. |       | Wijz. 04: |          |          |             |            |          |          |          |
|  |               |       | Wijz. 05: |          |          |             |            |          |          |          |
| © HAGO Electronics No part of this drawing may be used in any form without written permission of the owner.  |               |       |           |          |          |             |            |          |          |          |

BACKSIDE VIEW OF SCNA-1 / SCNA-2

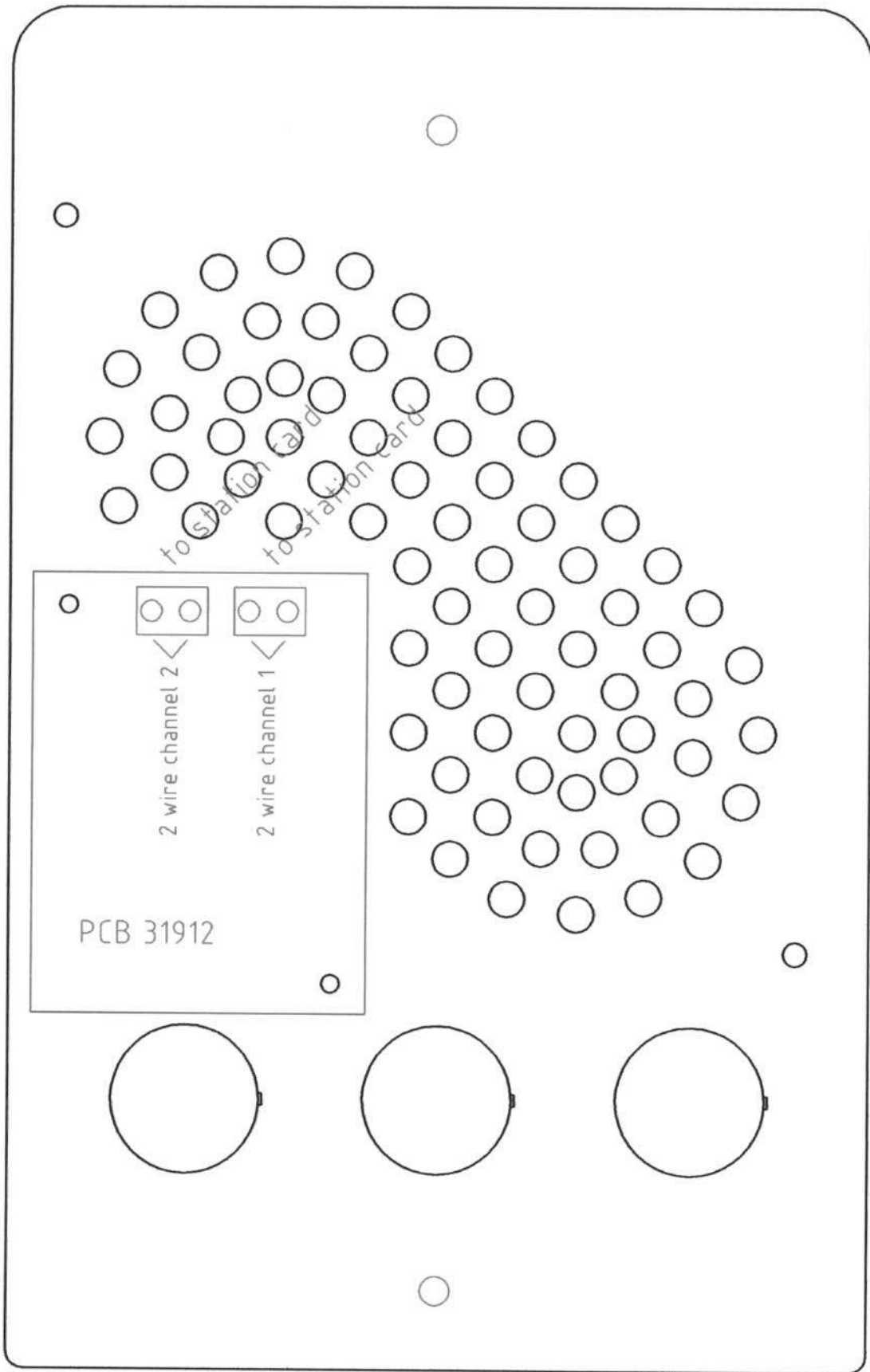

|  |               |       |           |          |         |         |             |          |  |
|--|---------------|-------|-----------|----------|---------|---------|-------------|----------|--|
|  <b>HAGO Electronics</b><br>Radonstraat 179<br>2718 SV<br>ZOETERMEER<br>The Netherlands<br>tel: ++31(0)79-3617555<br>fax: ++31(0)79-3619555 | Blad          | 1 / 1 | Wijz. 01: | Getekend | FV      | Paroof: | Contr. DAT: | Benaming | connection of<br>1 and 2 channel station |
|  | Maateenheid   | mm    | Wijz. 02: | Datum    | 6-11-97 |         | Contr. PAR: |          |  |
|  | Schaal        | 1:1   | Wijz. 03: | Order    |         | Project | Standaard   | Tek.nr.  | 41336                                    |
|  | Amerik. Proj. |       | Wijz. 04: |          |         |         |             |          | A4                                       |
|  |               |       | Wijz. 05: |          |         |         |             |          |  |
| © HAGO Electronics No part of this drawing may be used in any form without written permission of the owner.  |               |       |           |          |         |         |             |          |  |



**BULGIN CONNECTOR**

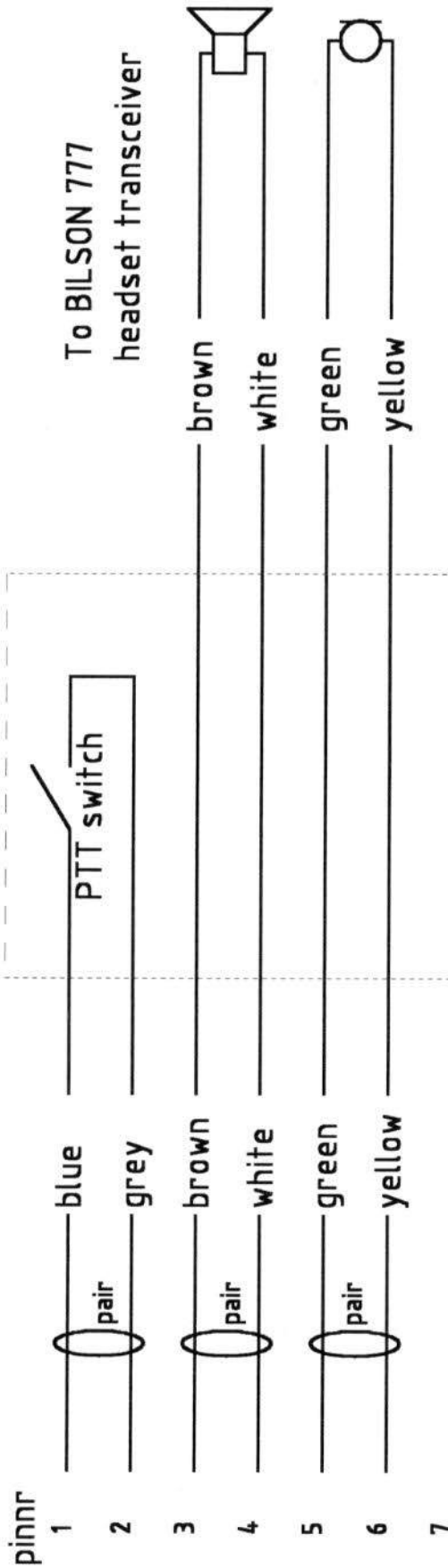

Use cable SP-HAG-001

↑

|  |               |       |          |          |          |          |         |             |           |                               |
|--|---------------|-------|----------|----------|----------|----------|---------|-------------|-----------|-------------------------------|
| <p>HAGO Electronics<br/>Radonstraat 179<br/>2718 SV<br/>ZOETERMEER<br/>The Netherlands<br/>tel: ++31(0)79-3617555<br/>fax: ++31(0)79-3619555</p> | Blaad         | 1 / 1 | Wijz.01: | 20-11-97 | Getekend | FV       | Paraaf: | Contr. DAT: | Benoeming | ShipCom                       |
|  | Maatstaf      | mm    | Wijz.02: |          | Debut    | 17-11-97 |         | Contr. PARE |           | Headset wiring                |
|  | Schaal        | 1:1   | Wijz.03: |          | Order    |          |         |             |           | Standaard Tek.nr. 41339-01 A4 |
|  | Amerik. Proj. |       | Wijz.04: |          |          |          |         |             |           |                               |
|  |               |       | Wijz.05: |          |          |          |         |             |           |                               |
| No part of this drawing may be used in any form without written permission of the owner.   |               |       |          |          |          |          |         |             |           |                               |

## View of Shipcom adjustment controls

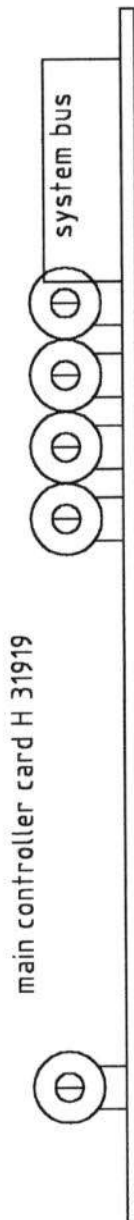

P1 = PA volume adjustment (only when PA module is placed)

P2 = Intercom volume

P3 = External source (music when connected)

P4 = Hailtone volume

P5 = Gain adjust intercomamplifier

Frontview of card

|  |             |   |          |          |            |        |              |                   |        |
|--|-------------|---|----------|----------|------------|--------|--------------|-------------------|--------|
| HAGO Electronics<br>Radonstraat 179<br>2718 Sv Zoetermeer<br>tel (31) 79 3617555<br>fax (31) 79 3619555<br>email hago@euronet.nl | Blad        | 1 | rev.01 : | Getekend | FV         | Paraaf | Contr. DAT : | Benaming          |        |
|  |             |   | rev.02   |          |            |        | 3-4-98       | ShipCom wiring-12 |        |
|  | Maateenheid |   | rev.03   | Datum    | 03-04-1998 |        | Contr. PAR:  |                   |        |
|  |             |   | rev.04   | Order :  |            |        |              |                   |        |
|  |             |   | n.v.t.   | rev.05   |            |        | Project      | ShipCom           | Teknr. |
| © HAGO Electronics No part of this drawing may be used in any form without written permission of HAGO Electronics                |             |   |          |          |            |        |              |                   |        |